

REF30RCBPNV

30" BUILT-IN REFRIGERATOR COLUMN, REVERSIBLE DOOR WITH INTERNAL WATER DISPENSER,
PANEL READY (STAINLESS STEEL PANEL KIT AVAILABLE)



Energy Star rated refrigerator with 16.6 cu.ft of total storage capacity, powered by variable-speed compressor and single evaporator.

Flush or proud installation in 84" high kitchen cabinets.

Dual Cooling Shield System: automated defrosting of evaporator ensures food stays always fresh.

Precise temperature dual zone control for optimal food preservation: the Fresco drawers with independent temperature settings (30° - 41°F) allows for optimal storage of meat, cold cuts, shellfish, fish and dairy products.

Internal water dispenser with inline filter for hygienically clean drinking water.

Digital LED touch interface with user-friendly controls for temperature, speed-cooling and eco mode.

Soft-close crispers with metal trims.

Height-adjustable gallon-size door storage bin.

Stainless steel door panel kit available as optional accessory. Stainless steel toe kick included in the unit. Connection kit for multiple installations included in freezer columns.

Reversible doors for left or right swing configuration.

Choose Professional, Master or Heritage Series handle kit to match your other Bertazzoni kitchen appliances. Purchase Décor Sets in Gold (DS2HERTGO), Polished Copper (DS2HERTPC) or Satin Black (DS2HERTSB) to personalize your Heritage Series handles (6 handle finials per set).

2 years parts & labor warranty and 5 years labor warranty for the entire sealed system.

ADA compliant.

PRODUCT FEATURES

Size	H: 83 9/16" W: 29 3/4" D: 23 5/16"
Door finish	Panel ready
Interior finish	Stainless steel back wall
User interface	Internal digital LED touch interface
Lighting	LED lights on sides and top
Shelves	1 stationary + 3 height adjustable
Drawers	1 crisper + 3 fresco drawers with separate temperature control
Door storage	1 height-adjustable gallon size + 2 stationary bins
Water dispenser	Yes - Internal
Modes	Super cool, Water filter replacement alarm, Water dispenser, Eco mode, Vacation mode, Sabbath mode
Open door alarm	Yes

INTERIOR CAPACITY

Total volume	16.6 cu.ft
--------------	------------

TECHNICAL SPECIFICATIONS

Electrical supply	115 V 60 HZ - 112 W 2 Amp
Power connection	NEMA 5-15P with 90" power cord
Sound rating	41 dbA
Energy consumption	325.0 kWh/yr
Water connection	1/4" waterline with shut-off valve
Water filter	Yes - internal
Water supply pressure	25-80 psi (1.7-5.5 bar)
Certification	ADA Compliant,CEC,ETL
Warranty	2 years parts & labor Sealed system: 5 years labor
Packaging dimensions and weight	W 32 1/4" H 90 9/16" D 26 3/8" 376.0 lbs

OPTIONAL ACCESSORIES

Z370749	Replacement water filter
SP30CX	Stainless steel door panel kit
PROHKCOL	Handle kit - Professional series
MASHKCOL	Handle kit - Master series
HERHKCOL	Handle kit - Heritage series



AIM YOUR CAMERA HERE

REF30RCBPNV

30" BUILT-IN REFRIGERATOR COLUMN, REVERSIBLE DOOR WITH INTERNAL WATER DISPENSER, PANEL READY (STAINLESS STEEL PANEL KIT AVAILABLE)



PRODUCT DIMENSIONS

SIDE VIEW

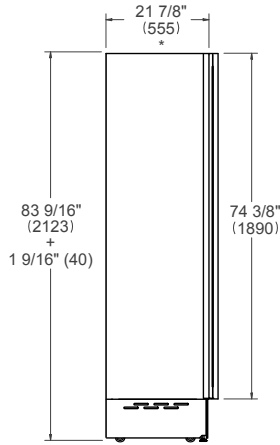

FRONT VIEW

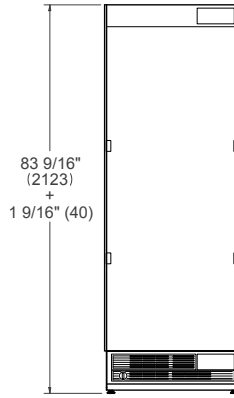

TOP VIEW

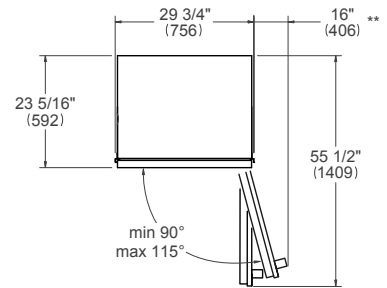

* Depth without door

** Maximum Overall Handle Dimension, 3/4" (19) door panel thickness

CUTOUT DIMENSIONS

SIDE VIEW

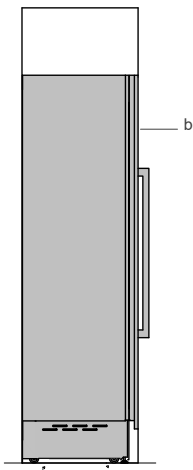

FRONT VIEW

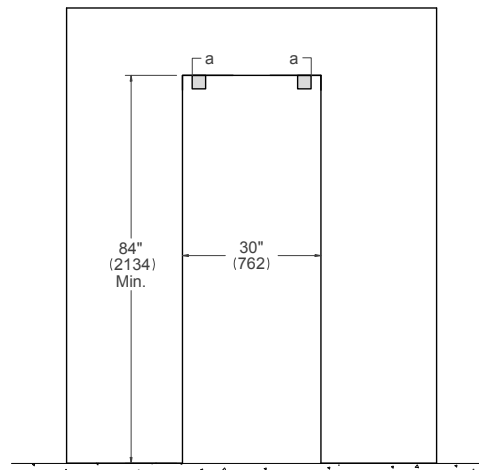

TOP VIEW

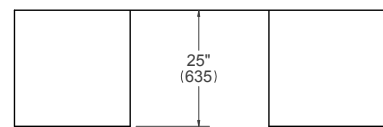

For a 25" (635) flush inset depth, max door panel thickness is 15/16" (24). Max door panel weight is 66 lbs (30 kg).

(a) Anti-tipping brackets – included with appliance

(b) Panel dimensions available on Door Panel Specs, Built-in Food Preservation Design Guide or Installation Manual

ELECTRICAL & WATER CONNECTION



A properly-grounded, horizontally-mounted electrical receptacle should be installed according to this drawing.



To connect to the water supply system, use a 1/4" waterline with a minimum length of 60" (1500).

Connection(s) placement within the opening may require additional cabinet depth.

TOP VIEW

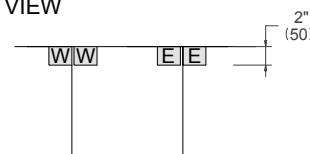

FRONT VIEW

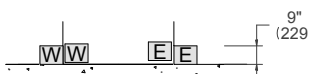

INSTALLATION REQUIREMENTS

If the appliance(s) is not connected through the side profile trims to secured cabinetry anti-tip brackets must be installed.

Dimensions in parentheses are millimeters unless otherwise specified.

A separate circuit breaker servicing only this appliance is recommended.

For installation of multiple products in combination, refer to the Built-in Food Preservation Design Guide at us.bertazzoni.com or ca.bertazzoni.com

Disclaimer: while every effort has been made to ensure the accuracy of the information contained in this document, Fratelli Bertazzoni reserves the right to change it at any time without notice. For detailed installation instructions, consult the installation manual. Fratelli Bertazzoni, Bertazzoni and the winged wheel brand icon are registered trademarks of Bertazzoni Spa.